

KARL MAYER

WE CARE ABOUT YOUR FUTURE

WARP PREPARATION

**COMPLETE SOLUTIONS
FOR YOUR SUCCESS
IN WEAVING**

Shirting / Sheeting / Denim / Home Textiles / Wool
/ Silk / Filament / Technical Textiles / Glass

2nd Edition



WARP PREPARATION

COMPLETE PROCESS

SOLUTIONS



ZERO DEFECT AND 100% CAPACITY UTILIZATION

One of our main objectives is to ensure that your weaving mill produces at the highest efficiency. We are the only manufacturer in the world who offers complete process solutions for the warp preparation business. Therefore we offer you the highest reliability for economic efficiency, quality and flexibility of your weaving factory.

Since 1991 we, as market leader, have been providing our customers with sustainable concepts. Innovative technology and reliable service structures guarantee the durability of your machines. KARL MAYER has agencies all over the world, at our customers' locations. Our global service network provides you with quick and targeted service solutions. Pre- and aftersales concepts support the long service life of your equipment and processes.

Our integrated processes ensure zero defect and 100% capacity utilization for your machines during production. Our Centers of Excellence develop special solutions for your complete business activities. We can also offer you tailor-made development solutions for your special requirements.

With our ground-breaking innovations we are always one step ahead. This competitive edge is the result of our professional development management and of our excellent relations to textile and technical colleges and universities. Our technology leadership also becomes evident by numerous applications of innovative patents.

This leaflet shows you our entire product portfolio and the appropriate technical solutions. Please kindly contact us if you have questions regarding your individual issues and wishes. Our experts are looking forward to meeting you and having a personal conversation with you. They would be pleased to hand you over detailed technical folders for your specific requirements.

We are looking forward to hear from you!

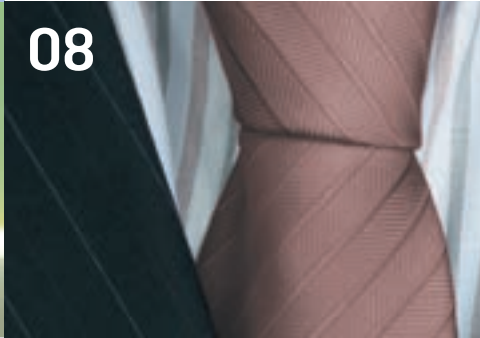

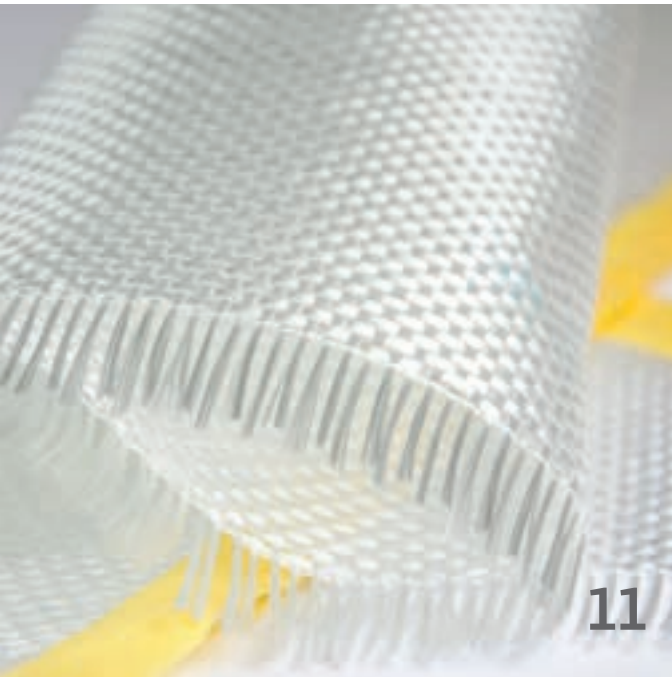

11

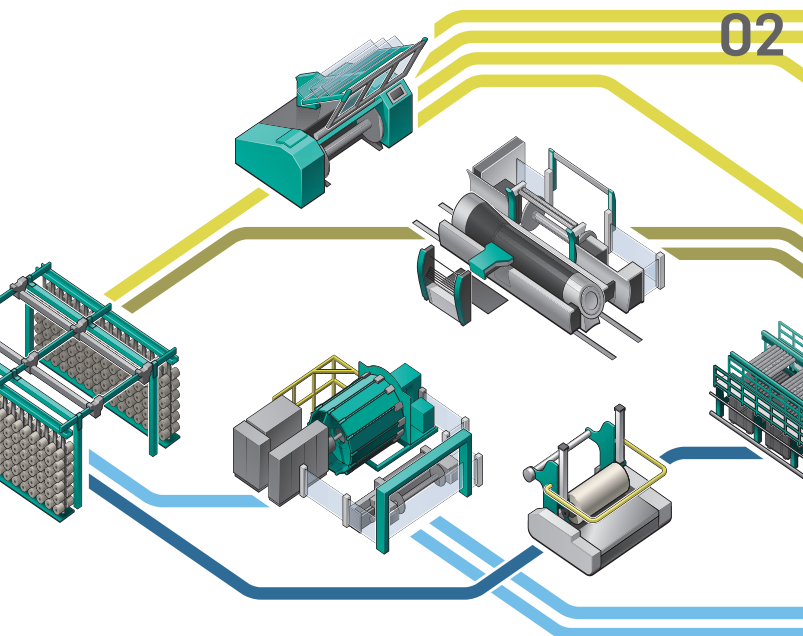

02

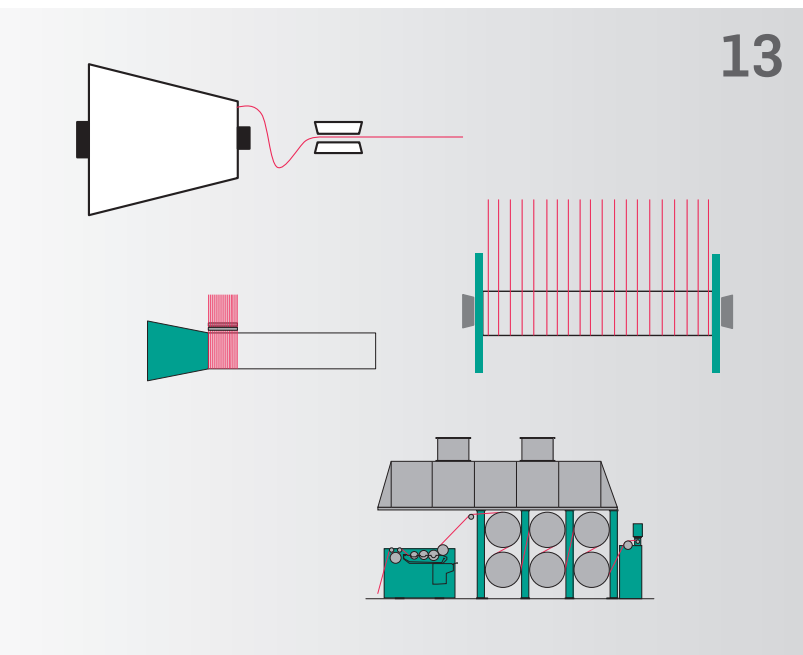

13

CONTENT

01 INNOVATIONS	6-7
02 COMPLETE SOLUTIONS	8-11
<hr/>	
03 SHIRTING	12
04 SHEETING	13
<hr/>	
05 DENIM	14
06 HOME TEXTILES	15
<hr/>	
07 WOOL	16
08 SILK	17
<hr/>	
09 FILAMENT	18
10 TECHNICAL TEXTILES	19
<hr/>	
11 GLASS – TECHNICAL SECTOR	20
12 GLASS – ELECTRONIC SECTOR	21
<hr/>	
13 PRODUCT OVERVIEW	22

INNOVATIONS

ALWAYS ONE STEP AHEAD



LINK-MATIC AUTOMATIC BATCH CHANGING SYSTEM

Full automation system to prepare beam creel by one operator. Increased productivity up to 25% and waste reduction by 450 m.

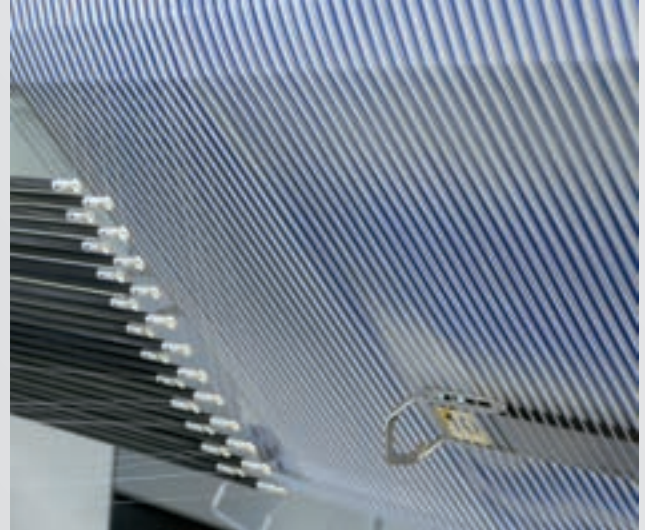

MM-32 PATTERN YARN SELECTOR MADE FROM CARBON AND PATENTED CENTER-YARN TRANSPORT FACILITY

Increased price performance up to 30% compared to GOM-24



INDIGO DYEING IN NITROGEN ATMOSPHERE

Cutting edge technology in indigo dyeing to increase up to three times pick-up dye vat at reduced water consumption

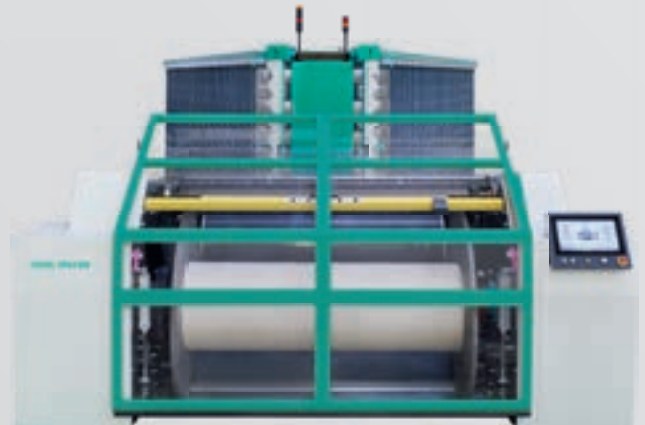

PRODIREKT WARPING MACHINE

User-friendly interface design for easier machine operation and insightful overview of production data. Electrically controlled high-precision pressure roller guarantees optimal results.

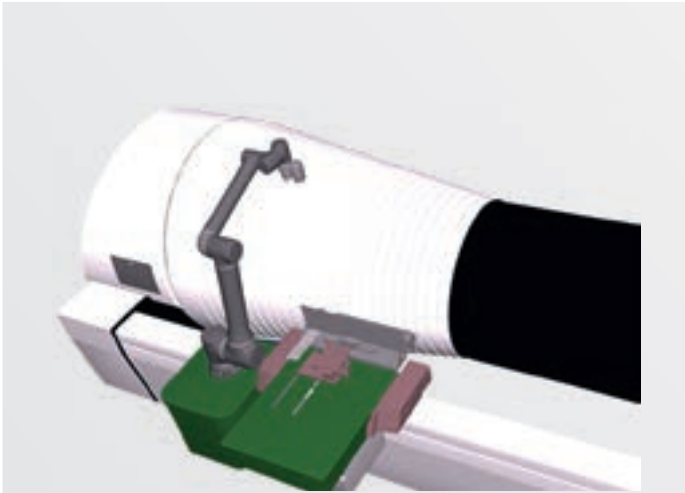

PRO ROBOT: ROBOTIC ARM ON WARPING TABLE

enables complete automation of warping process from fixation of first band on drum until the warping order is completed.

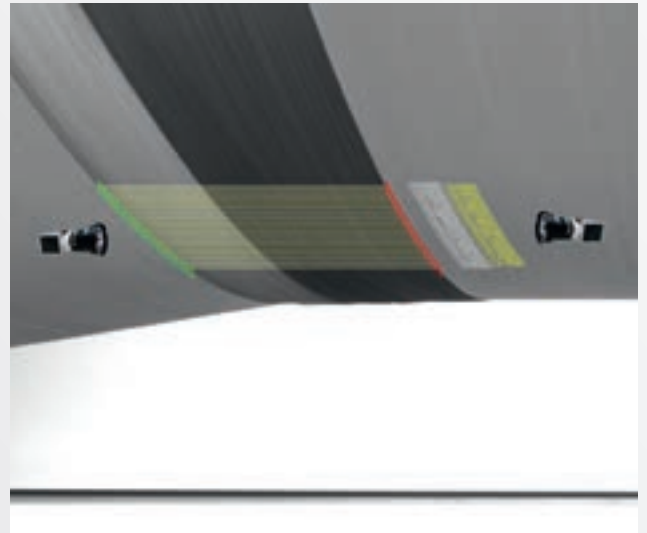

CAMERA BASED QUALITY CONTROL

Precise measurement of band width for better quality control with digital image processing through high resolution camera system

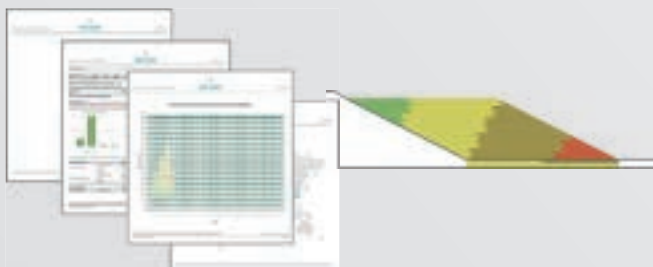
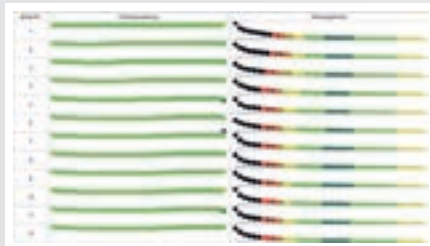

PRO-ACTIVE WARPING

Cloud-based self-learning of warping process. Clear summary of warp build-up as diagrams and presentations of deviations with understandable coloured evaluations.

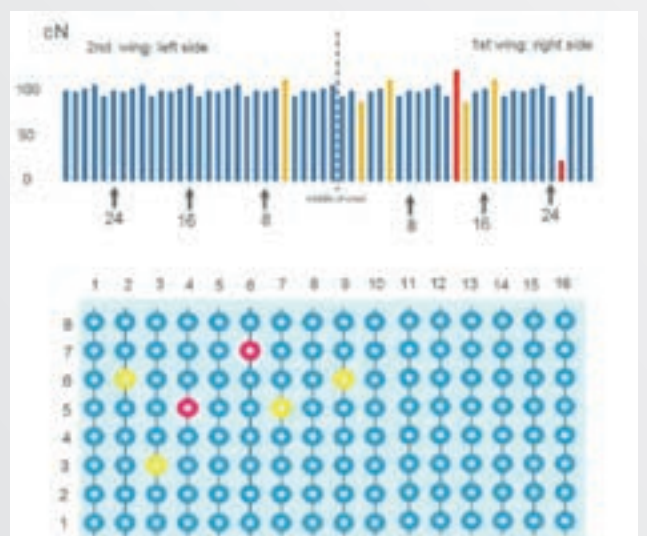

MULTI GUARD

Individual yarn breakages and yarn tension monitoring. Graphical display of yarn tension and yarn breakages positions.

PROCESS OVERVIEW

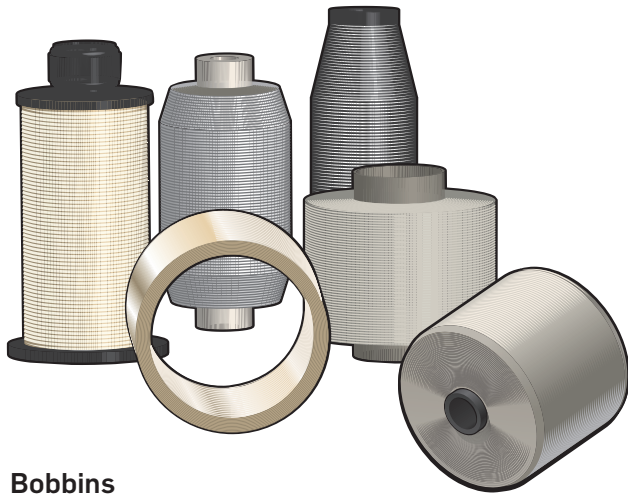

Bobbins

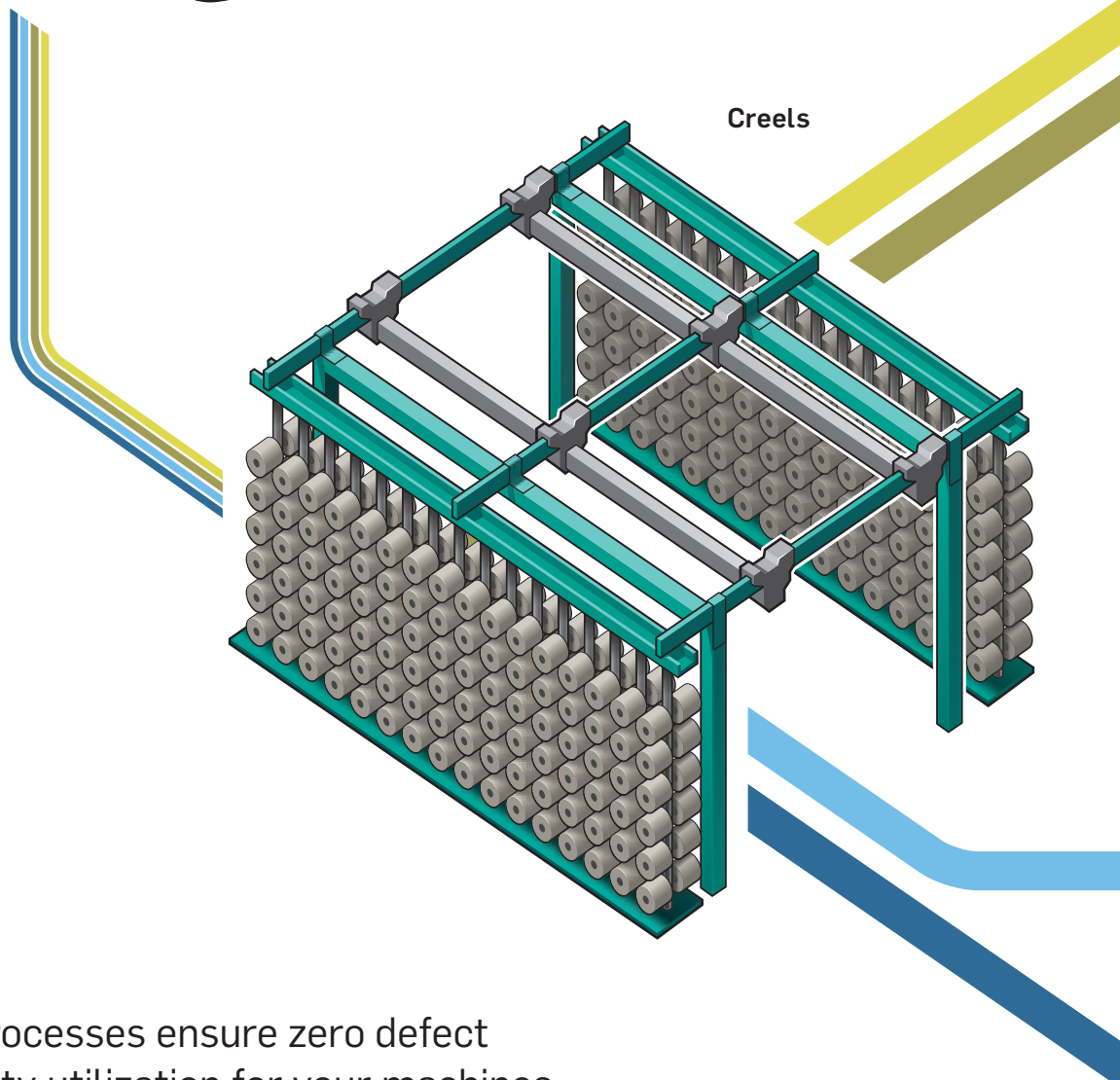

Creels

Our integrated processes ensure zero defect and 100% capacity utilization for your machines during production.

**Direct
Warping**

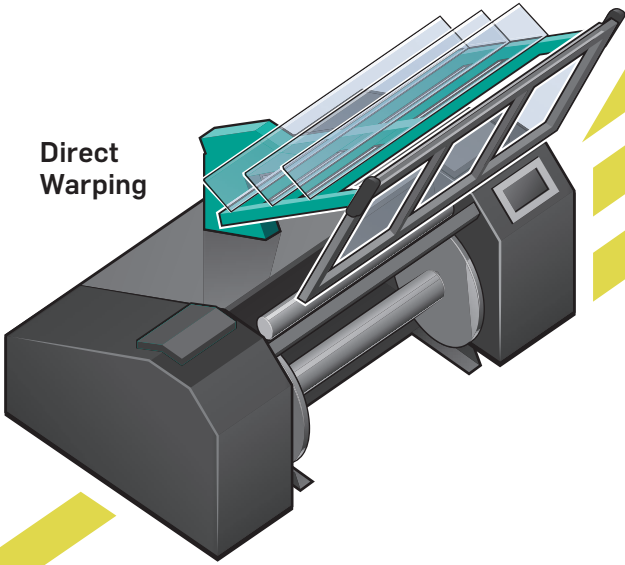

Sectional Warping

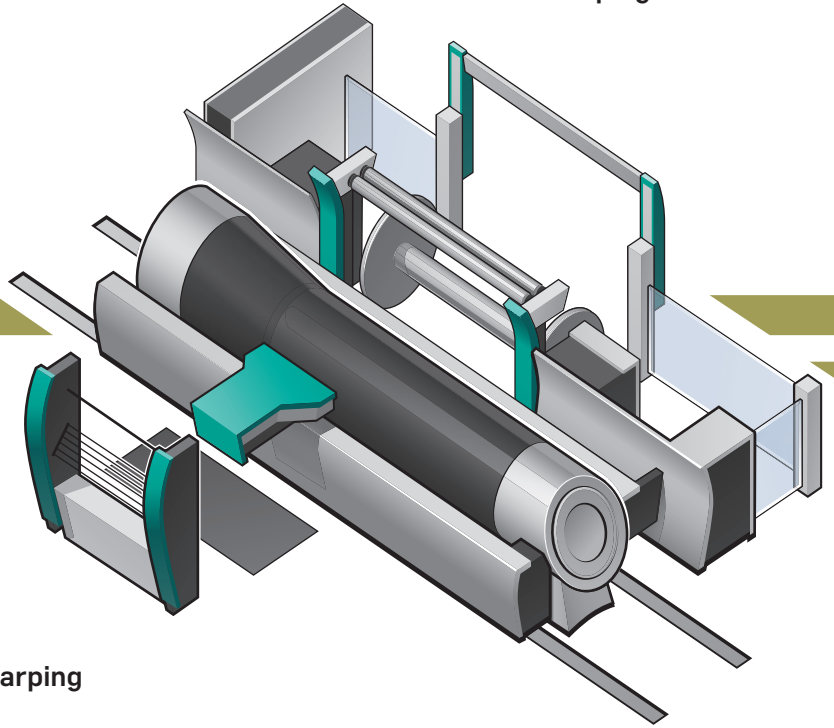

Sample Warping

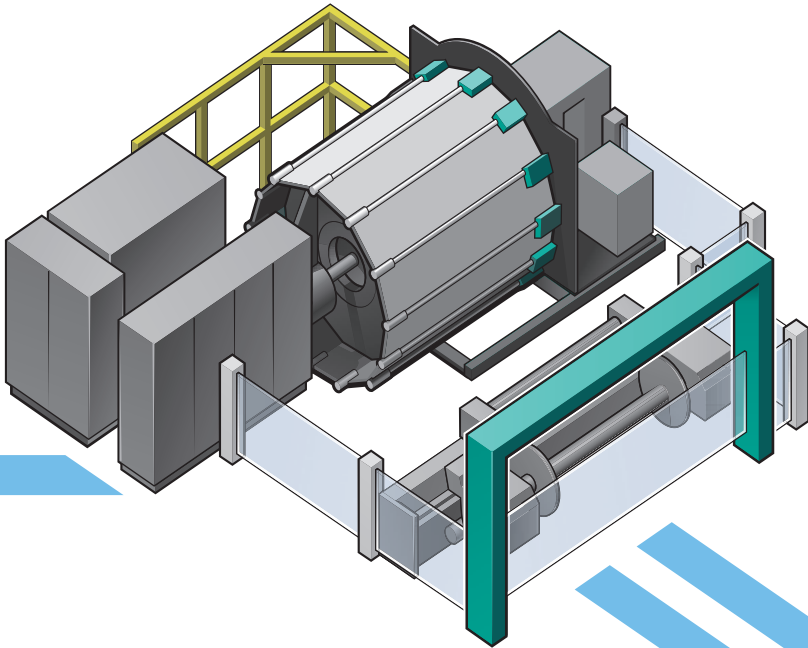

Ball Warping

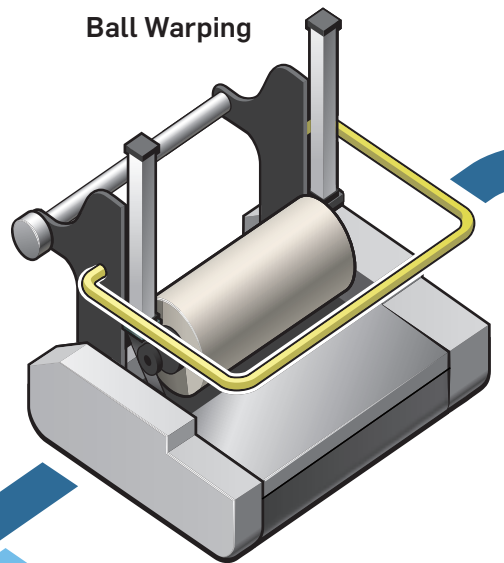

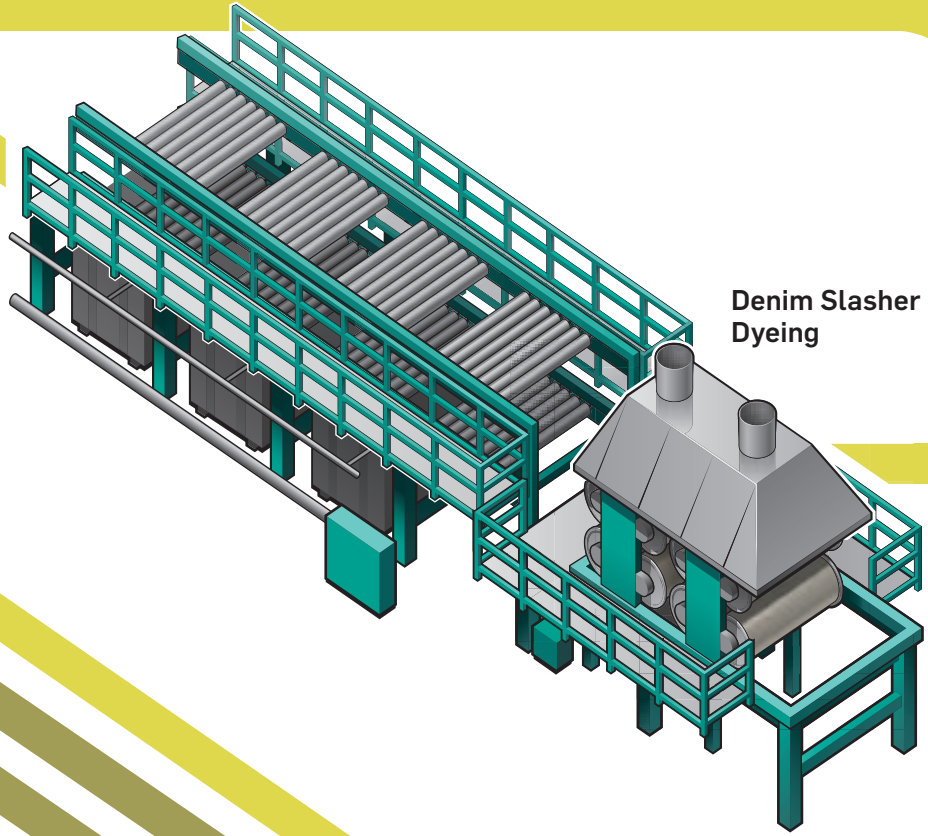

Denim Slasher
Dyeing

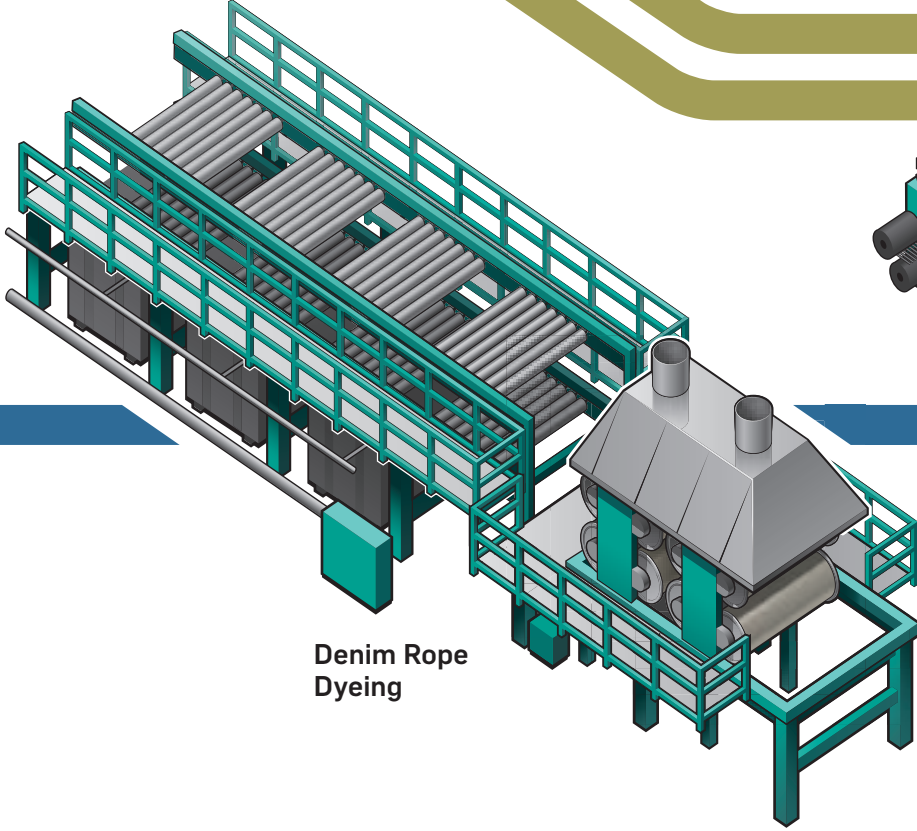

Denim Rope
Dyeing

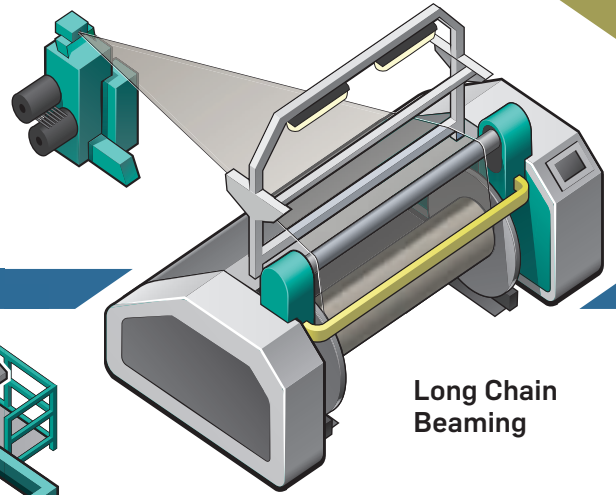

Long Chain
Beaming

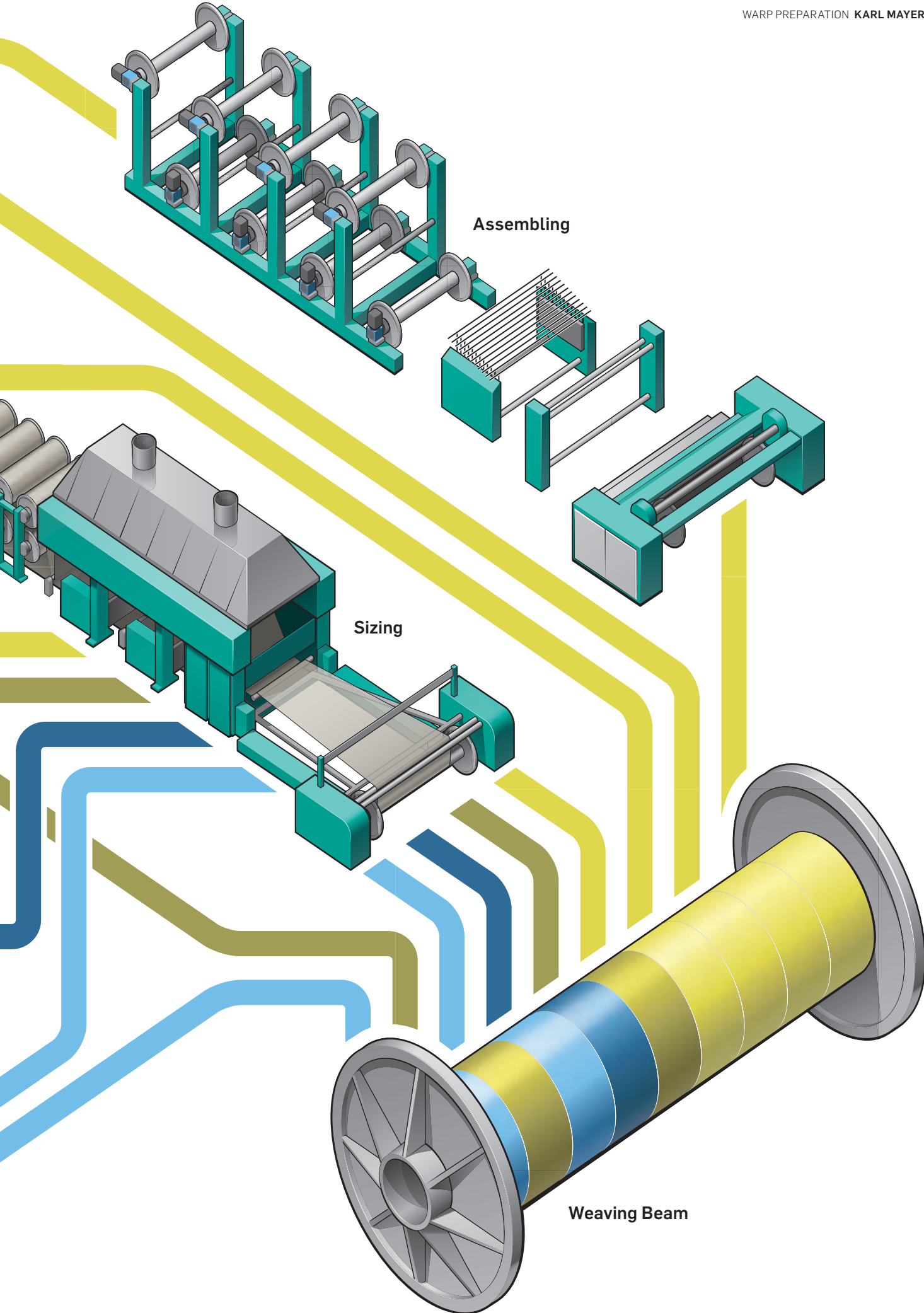



SHIRTING

TAILOR-MADE ORDER HANDLING

Only a made-to-measure shirt has a perfect fit. And only a made-to-measure order handling in warp preparation for weaving guarantees maximum quality as well as cost-efficient solutions. Regardless of whether you want to process raw or dyed yarns, in batches of short or long lengths, whether you want to produce plain or striped fabrics – with KARL MAYER's flexible machines you can always be sure to manufacture first-class warp beams in a most efficient and favourably-priced way.

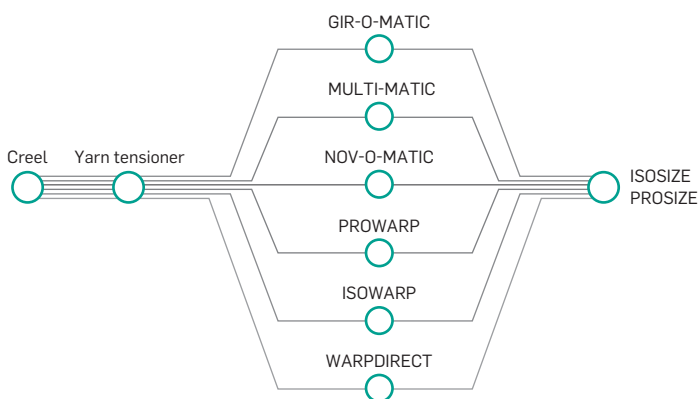

YOUR BENEFIT

First-class quality

- Shirting made of dyed or raw yarns of outstanding quality
- Plain or striped textiles
- Reproducible results in terms of density and colour
- Minimum yarn breakage rates during all process stages
- Unsurpassed gentle yarn treatment for first-class results
- Gives your designers a vast scope to express their creativity

Process know-how and profitability

- Specialized system expertise and complete product portfolio
- Improved machines for batches of short and long meters
- Electronic control system for highest process reliability
- Flexible technology for all requirements
- Cross-process quality management



YOUR BENEFIT

First-class quality

- 100 % reproducible quality due to automatic process control
- Minimum yarn breakage rates during all process stages
- Unsurpassed gentle yarn treatment for first-class results

Process know-how

- System expertise and complete product portfolio
- Improved machines for warp beams with 15,000 and 30,000 yarn ends
- Electronic control system for highest process reliability
- Flexible technology for all requirements
- Cross-process quality management

Profitability

- Permanently high productivity in warp preparation for weaving
- Minimum yarn breakage rates
- High efficiency
- More process reliability and higher productivity in weaving
- Production-supporting services such as remote maintenance of the machines

SHEETING

MORE COMPETITIVENESS

In times of decreasing profit margins and ever increasing competition you can take advantage of state-of-the-art machines offering highest efficiency, thus, being the decisive basis for more competitiveness. Successful weaving mills rely on KARL MAYER's machines. No matter which raw materials are used and which specific products and qualities are to be achieved, KARL MAYER's warp preparation machines ensure reliable production cycles, consistent quality and the decisive increase in productivity.

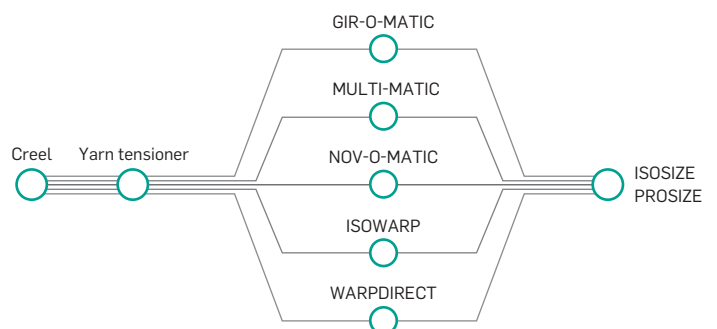



DENIM

PRODYE – THE KEY TO SUCCESS

Denim as an “evergreen” product in the clothing sector has increasingly developed to a sophisticated fashion article with personal touch and rapidly changing trends. Therefore, flexibility is the number one success factor for weaving mills. With its PRODYE KARL MAYER offers you the entire denim process technology for weaving warp preparation from a single source. It doesn’t matter whether you decide on the slash-dyeing procedure or on the rope-dyeing method, KARL MAYER’s PRODYE is always the most productive and economical solution.

YOUR BENEFIT

First-class quality

- Extremely wide range of colours and unique look of your denim products
- 100 % reproducible quality due to automatic process control
- Uniform yarn guiding for ensuring the best dyeing and sizing results
- Keeping the original yarn properties
- Higher intrinsic value of your products for higher profit margins

Process know-how

- Outstanding flexibility
- Additional components for special effects in the dyeing process
- Intelligent control system for optimum tension control and gentle-to-yarn sizing
- High-grade yarn tensioners for uniform, lowest yarn tension
- High ease of operation
- Maximum protection against soiling

Profitability

- 20 % more productivity in slash-dyeing
- Low wastewater pollution
- Highest efficiency due to reduced yarn breakages and optimum yarn quality
- Cleaning during machine operation ensures more productivity

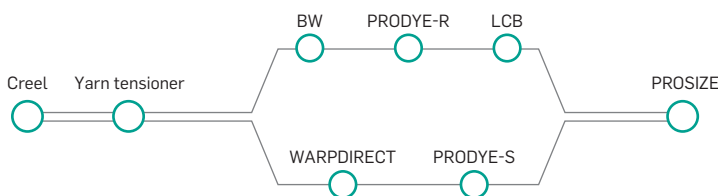



YOUR BENEFIT

First-class quality

- 100 % reproducible quality due to automatic process control
- Best results thanks to uniform yarn tension
- Minimum yarn breakage rates in all process stages

Process know-how

- Specialized system expertise and complete product portfolio
- Customized, optimized machines
- Production of wider warp beams of up to 3.60 m
- Electronic control system for highest process reliability
- Flexible technology for all requirements
- Cross-process quality management

Profitability

- Profitability calculations offered by our team of experts
- More efficient processes due to highest productivity in the long term
- Reduction of manufacturing costs
- Production-supporting services such as remote maintenance of the machines

HOME TEXTILES

COMPETITIVE EDGE THANKS TO EXPERTISE

Gain the lead and make use of KARL MAYER's expertise to achieve a faster and more economical production with highly efficient machines. Based on reliable profitability calculations KARL MAYER's experts are able to offer you the ideal solution for your weaving warp preparation business. Become more competitive by means of special solutions. Machines of double width ensure, for example, an efficient patterning for upholstery fabrics.

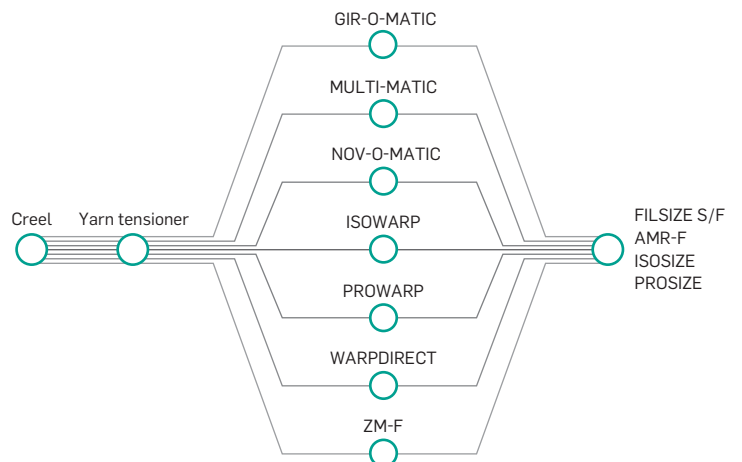



WOOL
EXCITING BY QUALITY

Experienced wool weaving mills know how to impress and delight sophisticated fashion labels: with exclusive quality at competitive prices. Perfect warp preparation with KARL MAYER's innovative technology is the key to success. It preserves the original properties of the delicate wool yarns and blended wool yarns, so that a faultless and productive operation is possible in weaving.

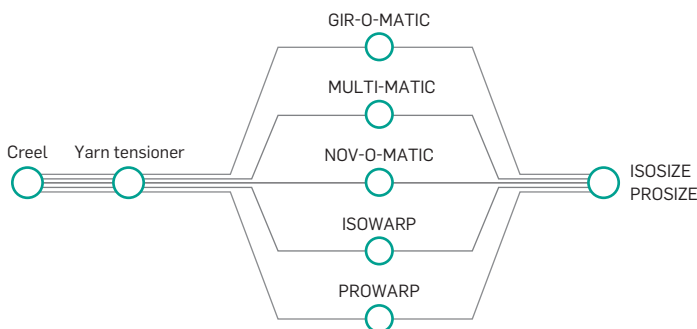

YOUR BENEFIT

First-class quality

- 100 % reproducible quality due to automatic process control
- Maximum accuracy for high efficiency
- Gentle yarn treatment due to uniform yarn tension
- Constant, completely homogeneous dyeing results

Process know-how

- Specialized system expertise and complete product portfolio
- Improved machines for efficient warp lengths
- Automatic warping with GIR-O-MATIC® and MULTI-MATIC®, maximum precision due to special warping bands
- Electronic control system for highest process reliability
- Flexible technology for all requirements
- Cross-process quality management

Profitability

- Less material usage, reduced waste
- Production-supporting services such as remote maintenance of the machines



YOUR BENEFIT

First-class quality

- 100 % reproducible quality even in case of an unsteady nature of the raw material, due to automatic process control
- Gentle yarn treatment and protection of the original yarn properties
- Uniform yarn guiding for obtaining best dyeing and sizing results
- Highest quality standard with "zero defect tolerance"

Process know-how

- Specialized system expertise and complete product portfolio
- Improved machines with maximum flexibility
- Uniform yarn tension by means of ISOTENS and MULTITENS
- Electronic control system for highest process reliability
- Cross-process quality management

Profitability

- Highest efficiency and maximum productivity
- First-class process reliability in weaving
- Reduced material usage and less waste
- Lower stock reserves due to just-in-time production
- Production-supporting services such as remote maintenance of the machines.

SILK

SPECIAL TREATMENT FOR A SPECIAL YARN

The prima donna amongst yarns is extremely demanding, and wants to be given a special treat during its processing from the bobbin to the loom. This is the reason why KARL MAYER developed the ISOTENS® and MULTITENS® yarn tensioners, a technology that guarantees a uniform yarn tension during the entire process of warp preparation for weaving, at the same time compensating for an unsteady condition of the raw material. When it comes to silk there's no room for compromises. Therefore, rely on KARL MAYER's machines.

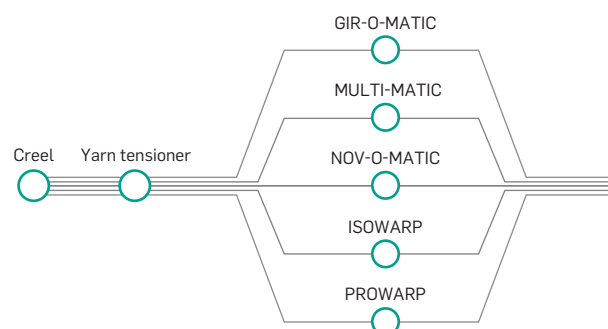



FILAMENT

ANYTHING IS POSSIBLE

The applications of filament yarns are almost unlimited. Lightweight, airy fashion fabrics, trendy functional garments, classical linings or technical textiles with particular properties – anything is possible. Therefore, high demands are made on warp preparation for weaving. For the special physical properties of filaments KARL MAYER can offer the most suitable process technology. Take advantage of the most flexible, most efficient and cost-saving solutions worldwide!

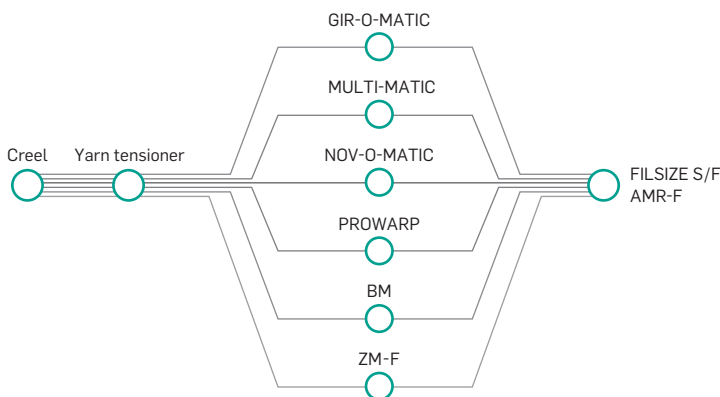

YOUR BENEFIT

First-class quality

- Perfect conservation of the original residual elongation of the yarn and of its other properties: from the first to the last meter
- Absolutely homogeneous dyeing results due to uniform yarn tension during direct beaming
- Highest process reliability in weaving due to uniform yarn tension and optimum sizing

Process know-how

- System expertise for all applications: from the finest monofilament yarns for filter fabrics up to high-tenacity multifilaments for tire cord
- Yarn guidings and yarn tensioners made from special wear-resistant ceramics
- Roller feeding devices for tension control in case of special applications
- Worldwide unique regulating systems in sectional warping, intermingling and sizing for continuous quality assurance

Profitability

- Achieving high potential savings in all process stages
- Highest efficiency due to yarn breakages reduced to minimum
- Competitive advantages thanks to reproducible best yarn quality
- Low current costs



YOUR BENEFIT

First-class quality

- Documented processes
- 100 % reproducible quality due to automatic process control
- Computer-controlled quality management for the entire process
- Wide range of materials to be used

Process know-how

- Specialized system expertise and complete product portfolio
- Improved machines for especially wide warp beams (up to 5.40 m) and high warp tensile forces
- Electronic control system for highest process reliability
- Flexible technology for all requirements
- Cross-process, documented quality management for all processes

Profitability

- Highest productivity in all applications
- High efficiency
- Reduced material usage, less waste
- Efficient, flexible processes with low personnel expenses
- Production-supporting services such as remote maintenance of the machines

TECHNICAL TEXTILES

PROVEN, DOCUMENTED QUALITY

Very often technical textiles make great demands on the quality management. Therefore, 100 % reproducible processes are a „must“ in warp preparation for weaving. In this respect, a highly specialized know-how is required because the processing widths and tensile forces exceed the usual dimensions many times over. But by using KARL MAYER's machines you will be able to master these challenges without any problems.

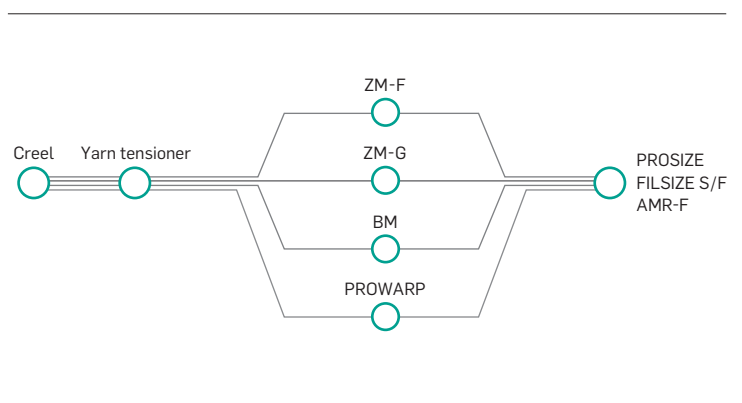

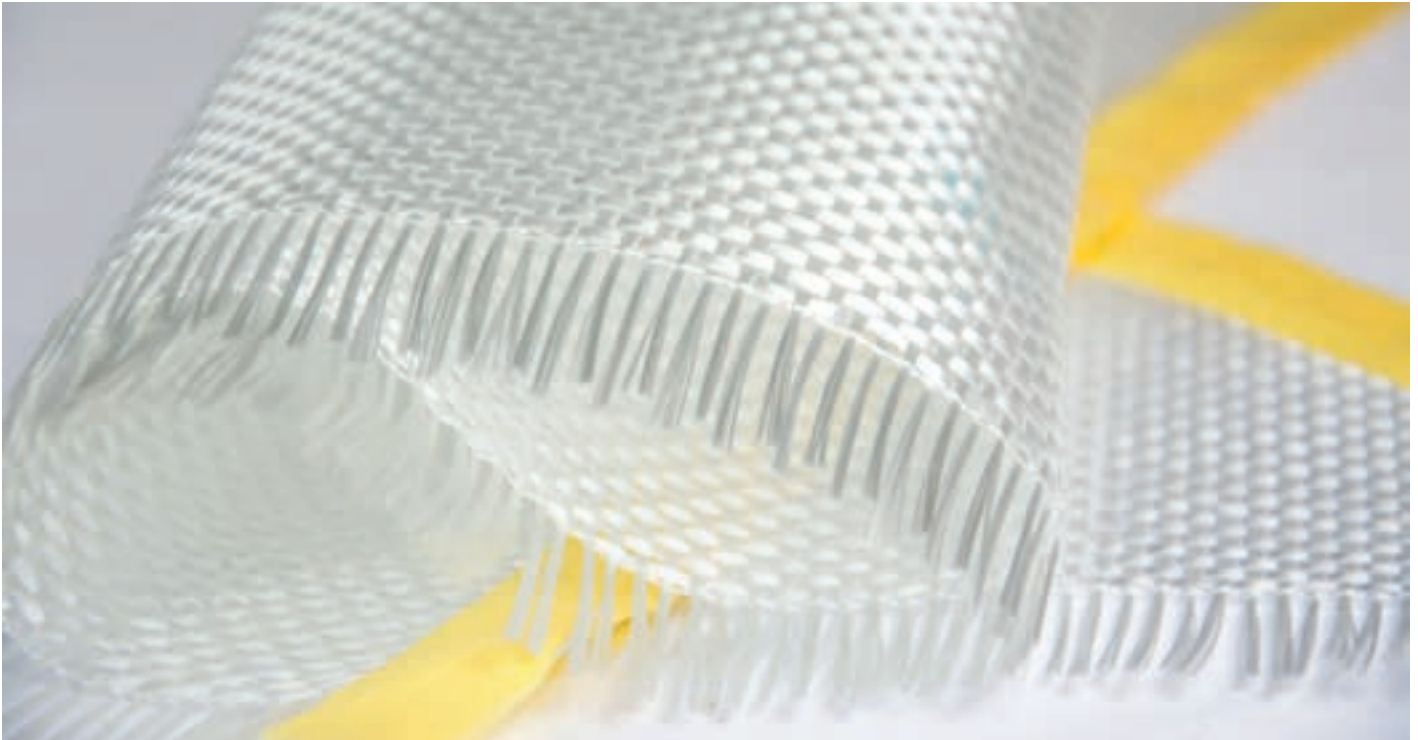

GLASS – TECHNICAL SECTOR
 HIGHLY SPECIALIZED COMPLETE SOLUTIONS

Consistent high quality, maximum process reliability and 100% reproducibility – KARL MAYER offers highly specialized complete solutions for glass processing for weaving warp preparation in case of which all the components are perfectly synchronized. In this way, you can control the complete process and can achieve unique results. KARL MAYER is a competent partner for glass weaving mills, with many years of experience in the field and offering an exceptionally wide service network.

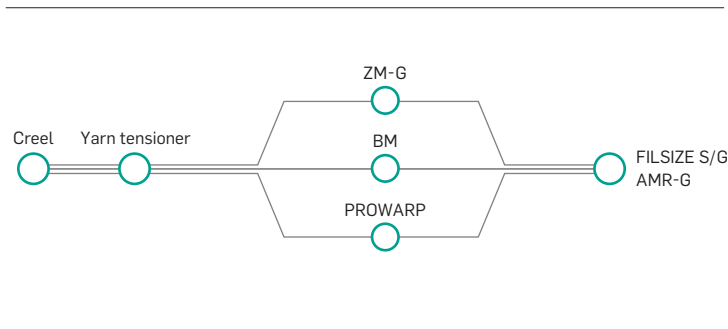

YOUR BENEFIT

First-class quality

- 100% reproducible quality due to automatic process control
- Computer-aided quality management during the entire process
- Homogeneous degree of sizing
- Precise winding structure

Process know-how

- Specialized system expertise and complete product portfolio
- Improved, innovative overall solutions for highest efficiency
- Camp-cross control of all production processes
- Electronic control system for highest process reliability due to KAMCOS®
- Perfect yarn tension and circumferential control
- Cross-process quality management
- Compensator-controlled assembling machines for the processing of very fine glass fiber yarns

Profitability

- Maximum productivity and highest efficiency
- Minimum yarn breakage rates
- Efficient and flexible processes for all yarn counts
- Production-supporting services such as remote maintenance of the machines

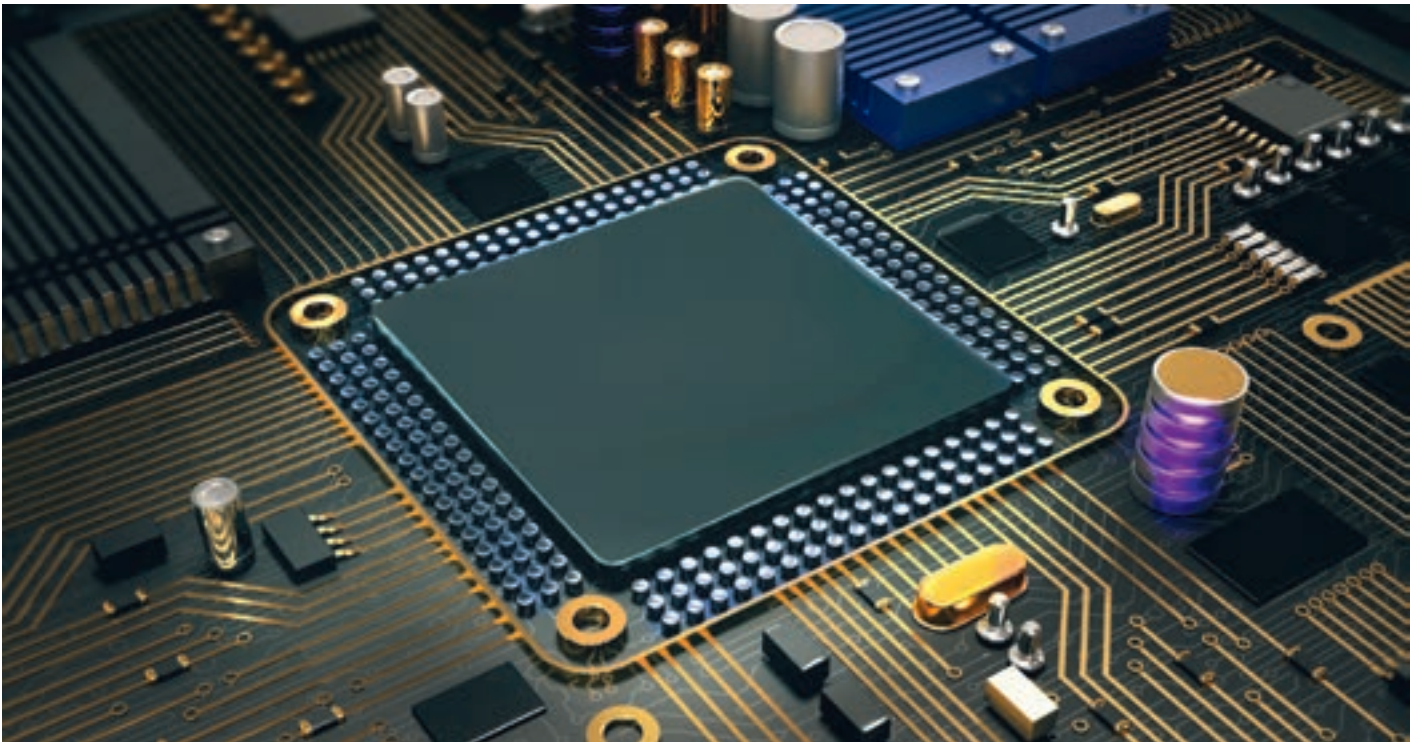

YOUR BENEFIT

First-class quality

- 100 % reproducible quality due to automatic process control
- Computer-aided quality management during the entire process
- Homogeneous degree of sizing
- Precise winding structure

Process know-how

- Specialized system expertise and complete product portfolio
- Improved, innovative overall solutions for highest efficiency
- Electronic control system for highest process reliability due to KAMCOS®
- Perfect yarn tension and circumferential control
- Cross-process quality management
- Compensator-controlled assembling machines for the processing of very fine glass fiber yarns
- **ACCUTENSE 0° for the gentle deflection of sensitive glass filament yarns**

Profitability

- Maximum productivity und highest efficiency
- Minimum yarn breakage rates
- Efficient and flexible processes for all yarn counts
- Production-supporting services

GLASS – ELECTRONIC SECTOR HIGHLY SPECIALIZED COMPLETE SOLUTIONS

Consistent high quality, maximum process reliability and 100 % reproducibility – KARL MAYER offers highly specialized complete solutions for glass processing for weaving warp preparation in case of which all the components are perfectly synchronized. In this way, you can control the complete process and can achieve unique results. KARL MAYER is a competent partner for glass weaving mills, with many years of experience in the field and offering an exceptionally wide service network.

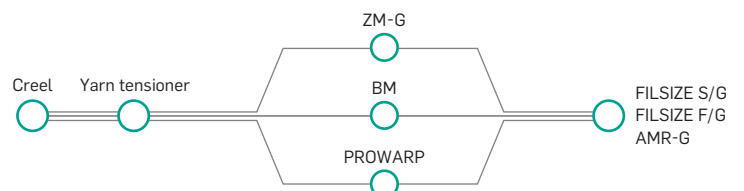

OUR PRODUCTS OVERVIEW

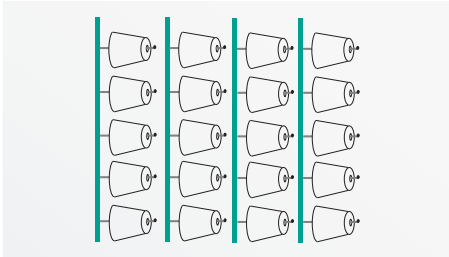

CREEL

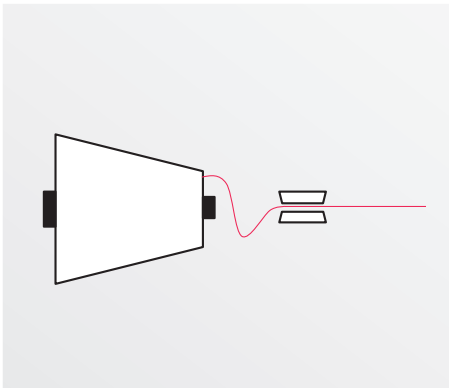

YARN TENSIONER

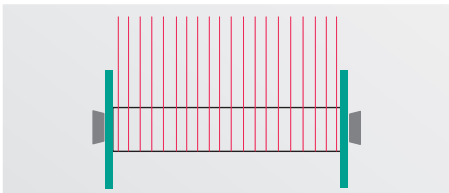

**BEAMING AND DIRECT
BEAMING MACHINES**

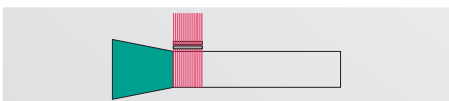

SECTIONAL WARPERS



**WARP SAMPLING
MACHINES**

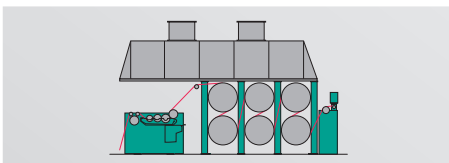

SIZING MACHINES

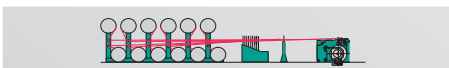

ASSEMBLING MACHINES



INDIGO DYEING UNITS

GN-1 – Standard creels
GM – Magazine creels
GD – Swivel-frame creels
GW – Carriage creels
GV – V-creels
GAR – Unwinding creels
GAM – Unwinding creels monofil
GAPP – Unwinding creels polypropylene
KFD-2
KFD-B
KFD-AIR
OPTOSTOP
U2V
U3V
DISCTENS
ISOTENS
MEGATENS
MULTITENS
ACCUTENSE 0°
ACCUTENSE 30°–90°
ZM-F – Direct warper for filament yarns
ZM-G – Direct warper for glass fiber yarns
WARPDIRECT – Direct warper for spun yarns
BW – Ball Warper
LCB – Long Chain Beamer
BM – Beaming machine
NOV-O-MATIC – Automatic sectional warper
PROWARP – Sectional warper
ISOWARP – Sectional warper
MULTI-MATIC (MM) – Warp sampling machine
GIR-O-MATIC (GOM) – Warp sampling machine
PROSIZE – Sizing machine for spun yarns
ISOSIZE – Sizing machine for spun yarns (old SMR-SP)
FILSIZE S/F
FILSIZE S/G
FILSIZE F/G
AMR-F – Assembling machines
AMR-G – Assembling machines
PRODYE
ROPEDYE

KARL MAYER Worldwide



Europe **Germany** Obertshausen, Chemnitz, Frankfurt, Naila **Italy** Mezzolombardo **Switzerland** Oberbüren **UK** Nottingham
Asia **China** Changzhou City, Hong Kong **India** Mumbai, Ahmedabad **Japan** Fukui-City
North America **USA** Greensboro

© KARL MAYER Textilmaschinenfabrik GmbH
Brühlstraße 25 · 63179 Obertshausen · Germany
www.karlmayer.com

The information provided in this document contains merely general descriptions or characteristics of which may change as a result of further development of the products. An obligation to provide the respective characteristics shall only exist if expressly agreed in the terms of contract. Availability and technical specifications are subject to change without notice. All rights reserved.